

OPERATOR'S MANUAL

SW99-04



SNOW WOLF



WARNING

- FOR AGE 18 YEARS OR ABOVE.
- PLEASE READ THE INSTRUCTION CAREFULLY BEFORE USAGE. MISUSE OR CARELESS USAGE MAY CAUSE SERIOUS INJURY.
- USER SHOULD OBEY TO ALL LAWS REGARDING THE USAGE AND OWNERSHIP OF GAS GUNS.
- FACIAL PROTECTION IS REQUIRED.

HANDLING CAUTIONS AND INSTRUCTION MANUAL

18 岁以上使用
FOR AGES 18 YEARS AND UP



SW99-04

1 Outlook / Structure of Sw04 Socom Sniper Always set the selector switch to the safe position when you are not firing or during storage

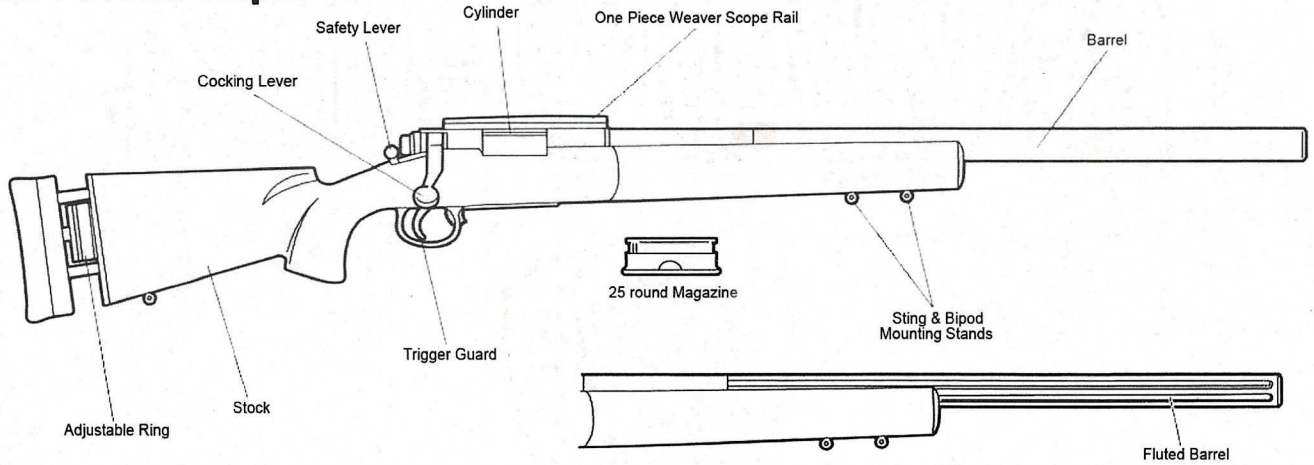
Sw04 Socom Sniper



Specification of Socom Sniper

Name	Sw04 Socom Sniper 'Military Type' With One Piece Fluted Barrel	Sw04 Socom Sniper 'Civilian Type' With One Piece Barrel
		
Weight	3.603kg	3.69kg
Barrel Length	515mm	515mm
Barrel Caliber	6.08mm	6.08mm
Pellet Capacity	25	25
Pellet	6mm BB	6mm BB
Initial Pellet Speed	85-105 m/Sec	85-105 m/Sec
Operation	Bolt Action	Bolt Action
Model No	S001M	S002M

2 Operation

1 How to use the Safety Lock

Pull the safety lever backward in order to make the safety function valid.

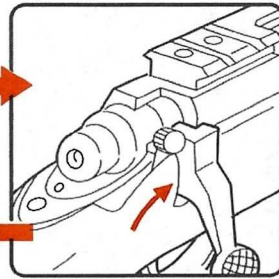
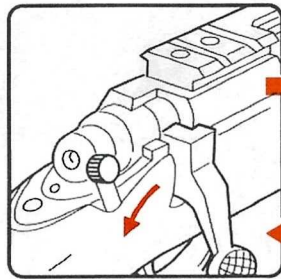

Push the safety lever forward in order to remove the safety function.

2 Procedure of Magazine Attachment / Detachment

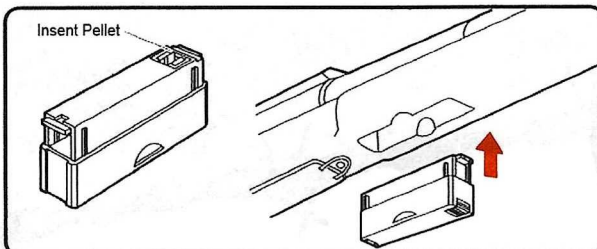

The pellet hatch in the magazine needs to be parallel to the muzzle's direction.

Holding the bottom of the magazine and push upward, until it's locked.

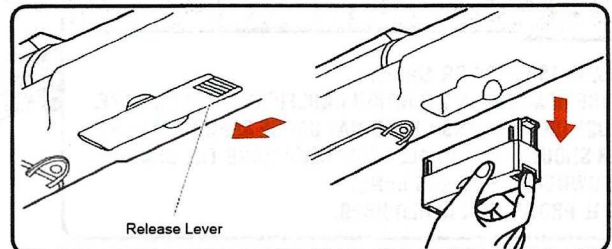

Please pinch tightly on the release lever, then pull it out from the barrel.



High precision is required for the operation of the magazine. Avoid invasion by dust and dirt into the magazine to prevent malfunctions.

3 How to Fire

CAUTION Always set the safety lever to the safety position when you are not firing or during storage.

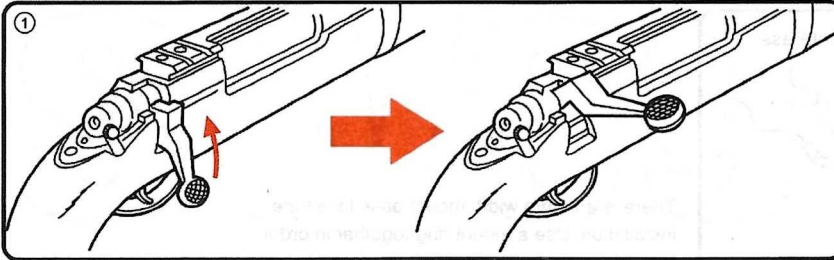

Push the cocking lever upward.

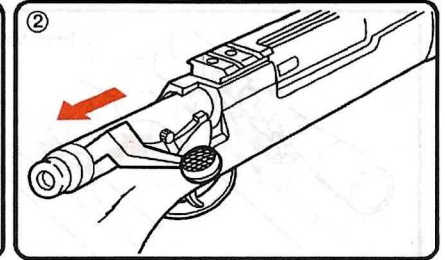

By then, pull the cocking lever backward in parallel situation until you heard a sound.

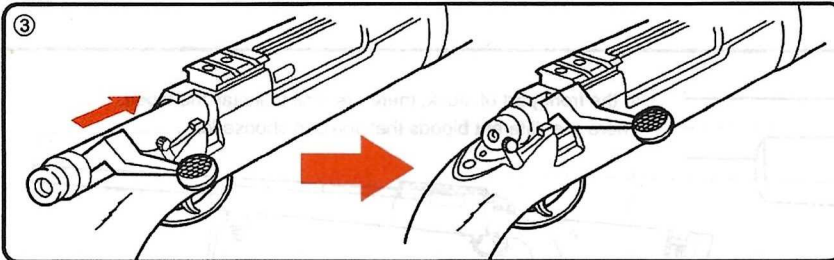

Keep the angle of the lever unchanged and push it forward.

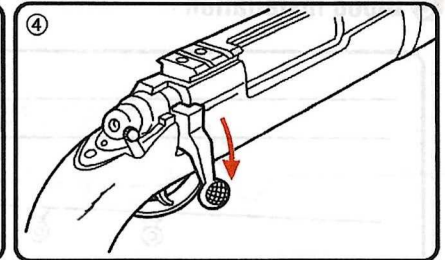

Put the lever back to the original position.

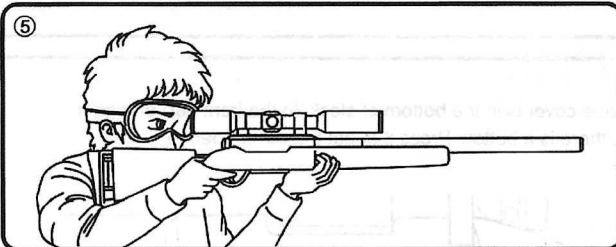

Make sure the target & shooting range is safety enough and it will not affect the others.

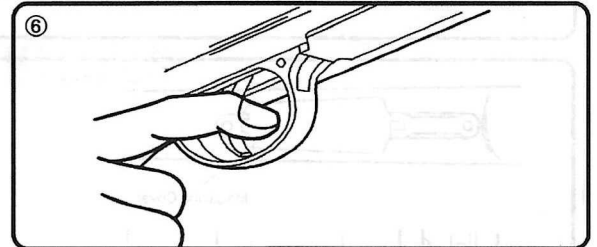

Put your finger hanging on the trigger, after confirming the direction of the target.

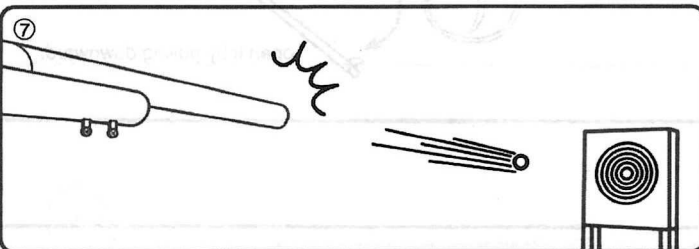

Point to your target and BB pellets will shoot towards.

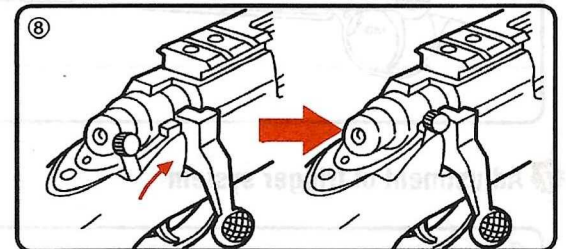

Unlock the safety function, push the safety lever forward.

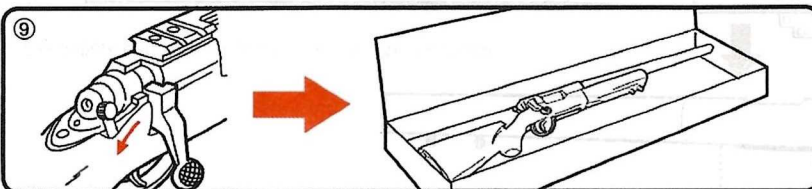

Pull down the safety lever and then please keep this condition in gun case.

4 Stock Adjustment

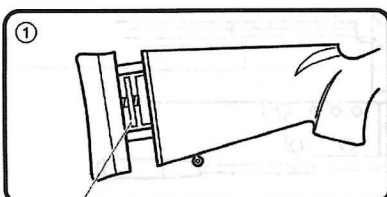

Loosen the lock ring

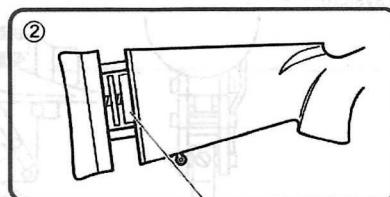

Adjust the length by turning the adjustable ring.
(Adjustable range: about 60mm)

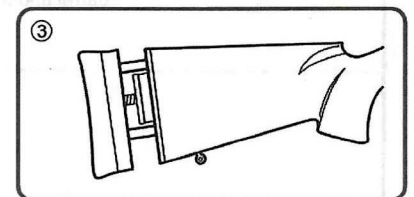

Fixed the length by locking the lock ring to the adjustable ring tightly.

CAUTION After shooting around 1000 BB pellets, please spray some silicone oil to the parts of the rifle.

5 Scope Installation

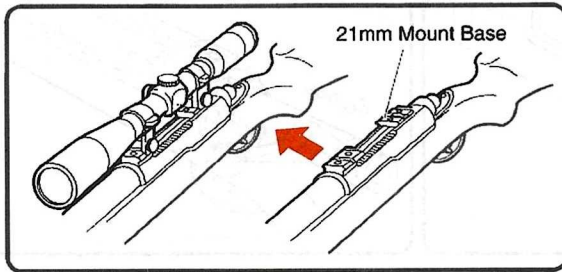

There is a 21mm width mount base for scope installation. Use a mount ring together in order to hold the scope on the gun.

6 Bipod Installation

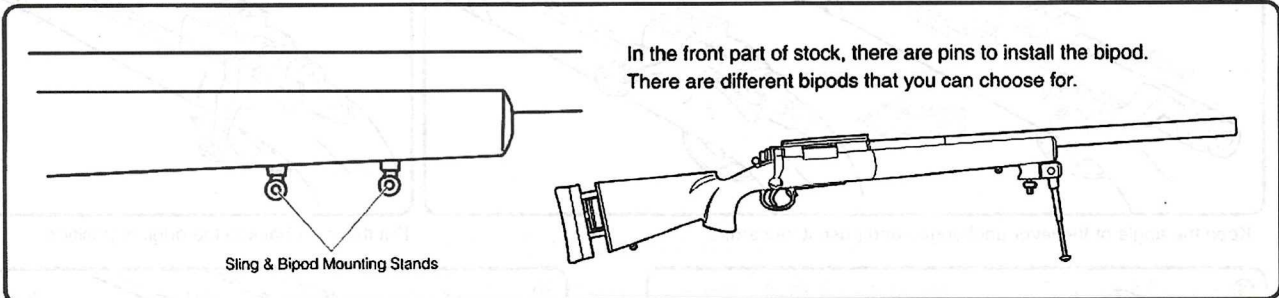

In the front part of stock, there are pins to install the bipod. There are different bipods that you can choose for.

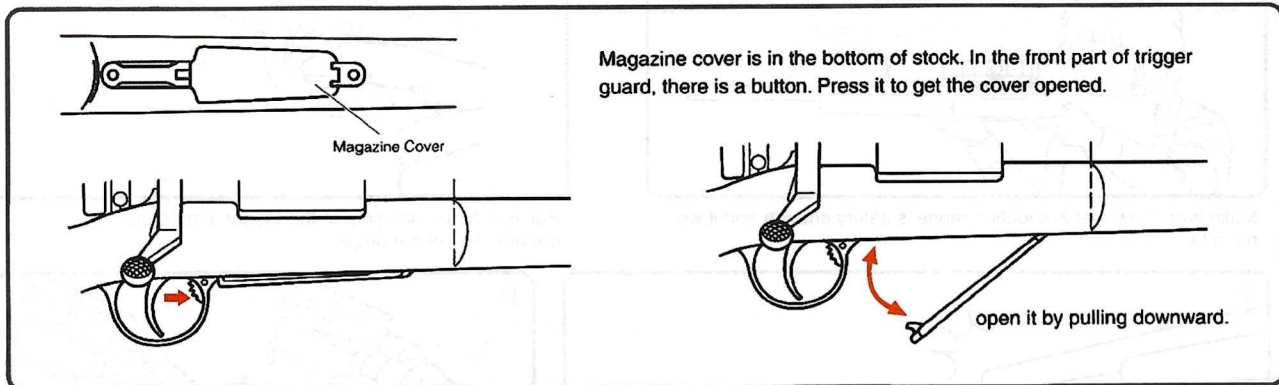

Magazine cover is in the bottom of stock. In the front part of trigger guard, there is a button. Press it to get the cover opened.

open it by pulling downward.

7 Adjustment of trigger system

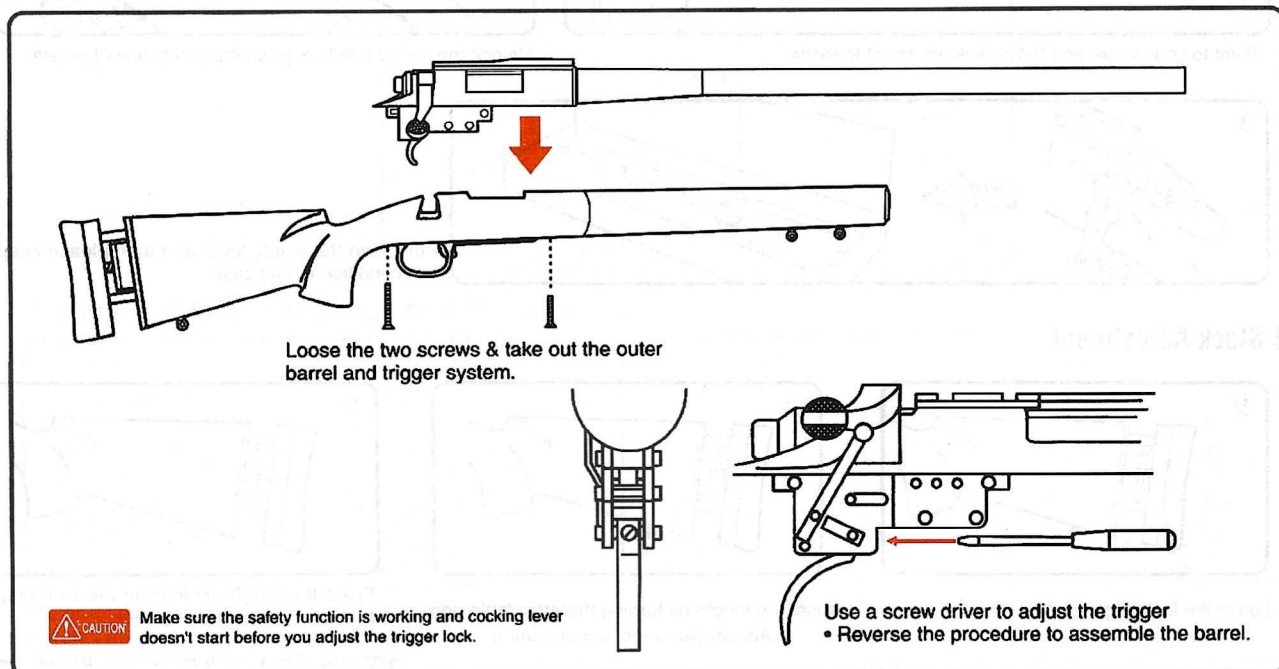

Make sure the safety function is working and cocking lever doesn't start before you adjust the trigger lock.

Use a screw driver to adjust the trigger
• Reverse the procedure to assemble the barrel.

SW99-04

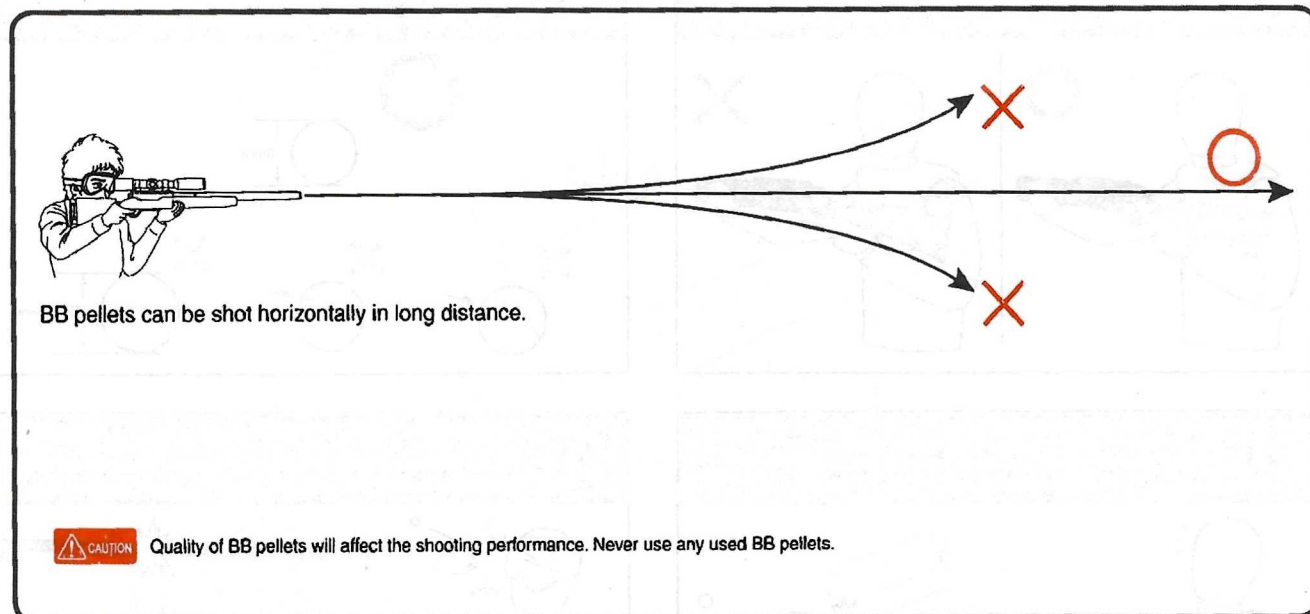
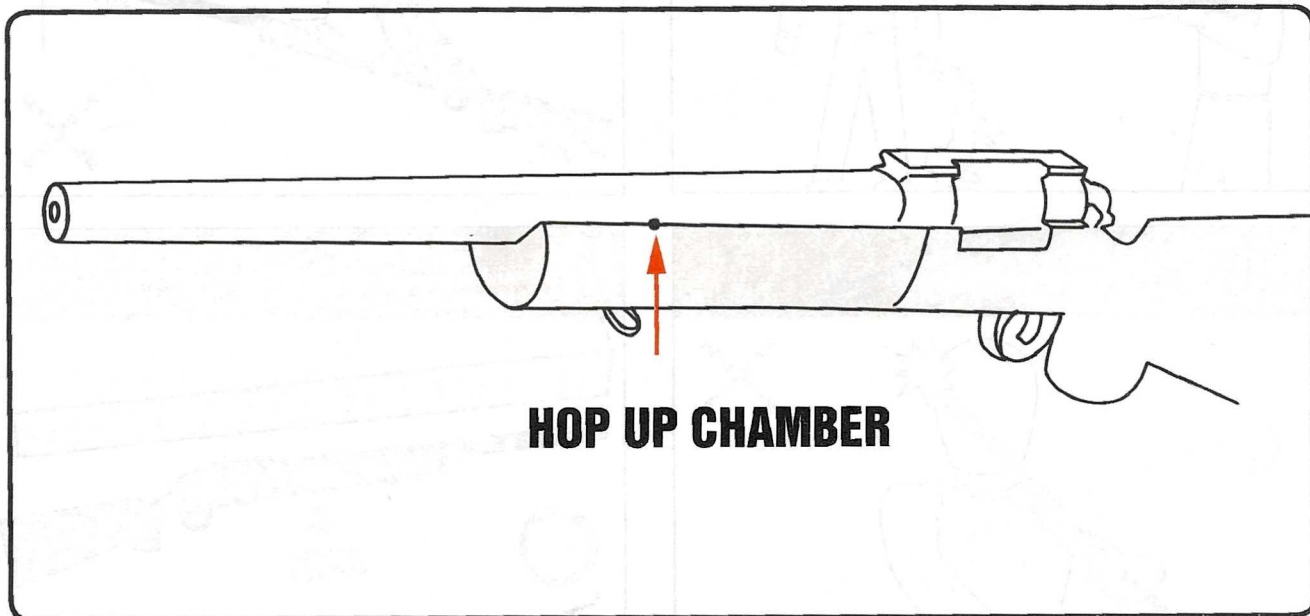

3 WARNING

Always read this manual before usage.

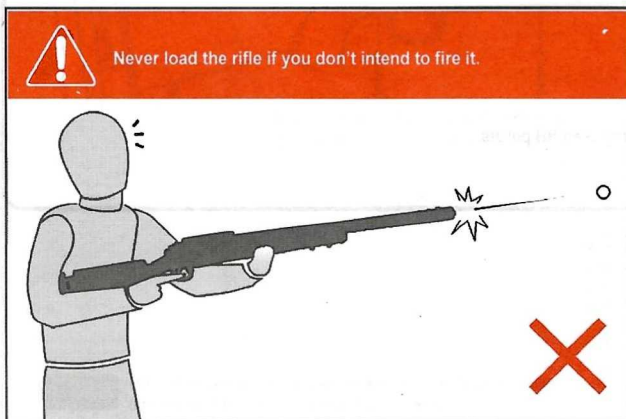
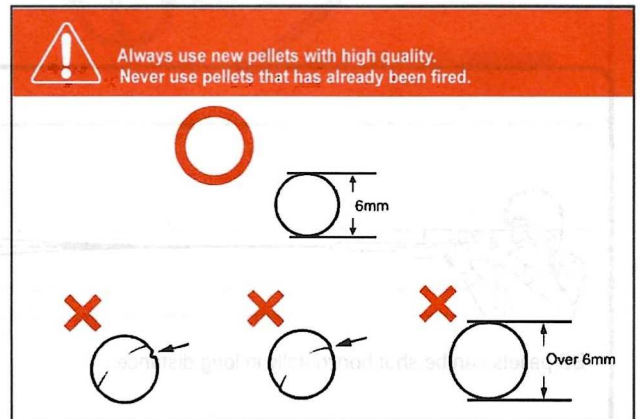
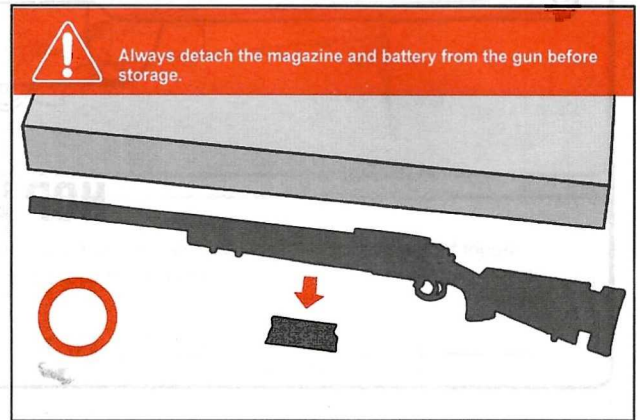
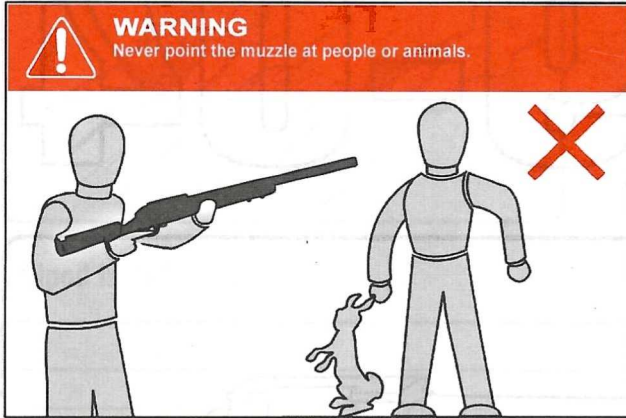

In no event shall Classic Army or any of our partners be liable for any direct or indirect, special, incidental, or consequential damages in connection with the use of our products.

4 Exploded Diagram

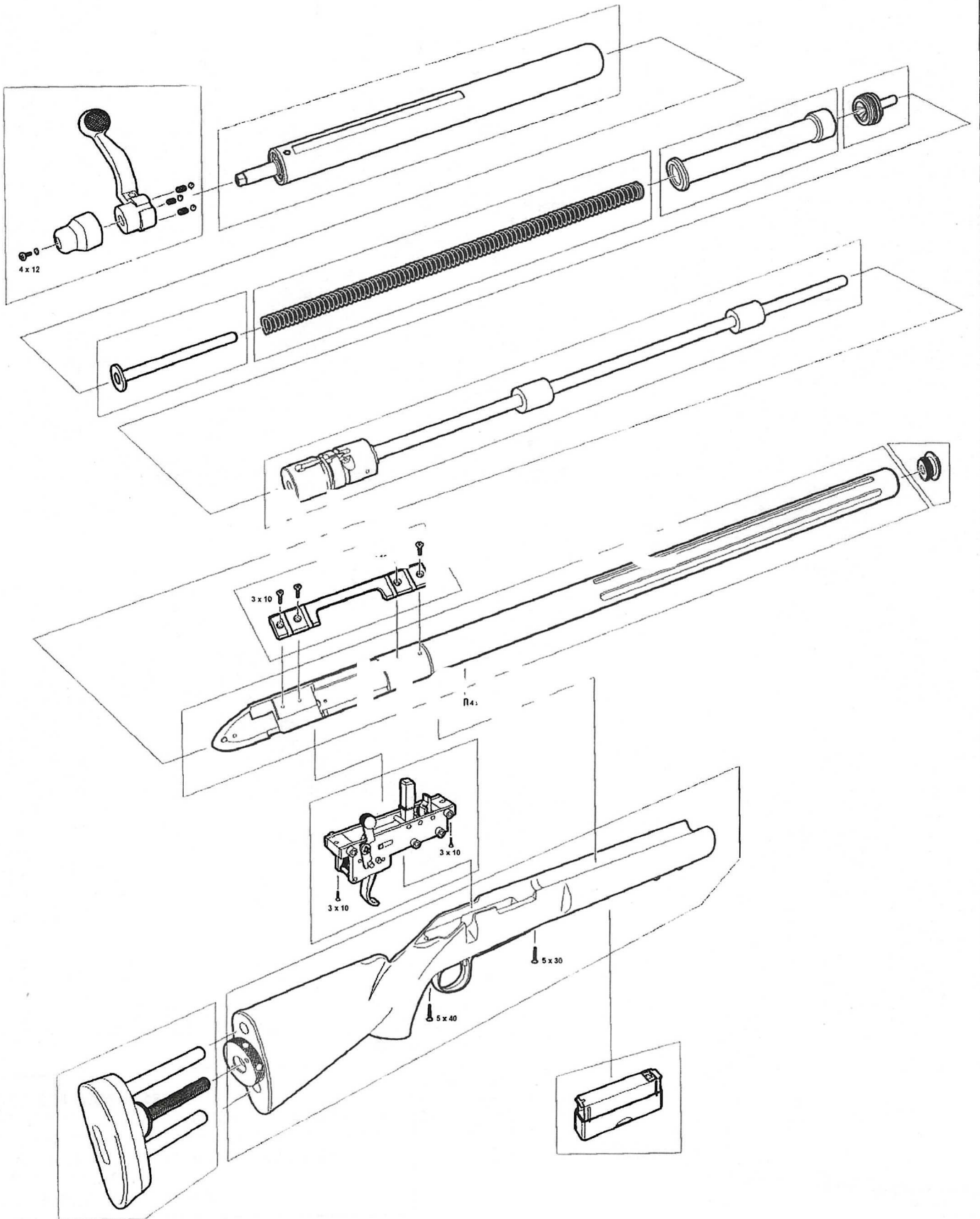

AirsoftPro



Remember to disassemble the gun after understanding the instruction thoroughly.